

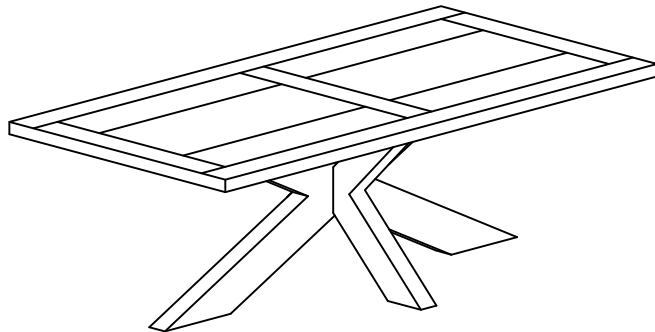



ASSEMBLY INSTRUCTION



NO.:	HARDWARE LIST	Q'TY
A		8
B		8
C		1
D		4

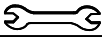